

Varenummer: 203180M1675B3U

Beskrivelse: E+G Justerfod

GN 31-80-M16-75-B3-U

Note: U Uden møtrik, sekskant i toppen, spændeflade i bunden

Mål

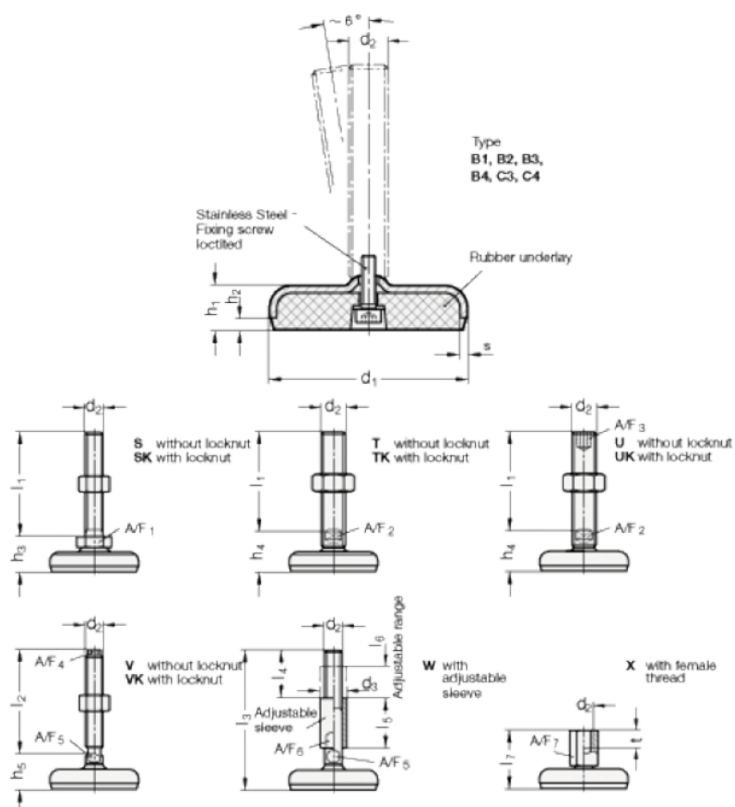

A/F2 = 12 | s = 3

A/F3 = 8

d1 = 80

d2 = 16

h1 = 18

h2 = 5

h4 +4.0/0 = 32

l1 = 75